

INSTALLATION NOTES:

1. FOOTING MATERIALS & INSTALLATION BY OTHERS. TOOLS BY OTHERS.
2. SCREWS AND BOLTS PROVIDED. LUMINAIRE ASSEMBLY PROVIDED. (SHIPPED SEPARATELY).
3. MAKE CONDUIT AND WIRING AVAILABLE THROUGH PIPE TO TOP OF BOLLARD INTERIOR.
4. CHOOSE DIRECTION WAYNE TYLER LOGO ON BOLLARD WALL SHOULD FACE. CAST-IN OR CORE DRILL (4) 1-1/2"DIA. x 5"DEEP GROUT POCKETS INTO FOOTING PER ANCHOR BOLT PATTERN.
5. TAKE (4) 1/2" DIA. x 4-1/2" LONG ANCHOR BOLTS AND SCREW AN INCH DEEP INTO (4) 1/2"DIA. S.S. THREADED INSERTS, LEAVING 3-1/2" OF THE ANCHOR BOLT EXPOSED.
6. FILL ALL GROUT POCKETS WITH NON-SHRINK GROUT. INSERT BOLLARD WITH ANCHOR BOLTS INTO GROUT POCKETS.
7. FASTEN MOUNTING INTERFACE PLATE TO BOLLARD TOP, ENSURING SUPPLY WIRING IS AVAILABLE FOR CONNECTION TO LUMINAIRE.
8. ENSURE POWER FEED IS DISCONNECTED. MAKE WET LOCATION CONNECTIONS WITH AC WIRES EMANATING FROM LUMINAIRE. WHITE IS NEUTRAL, BLACK IS POSITIVE.
9. PLACE LUMINAIRE COLLAR OVER MOUNTING PLATE AND CINCH WITH TWO 5/64" HEX (ALLEN) SET SCREWS.
10. TEST TO ENSURE OPERATION.

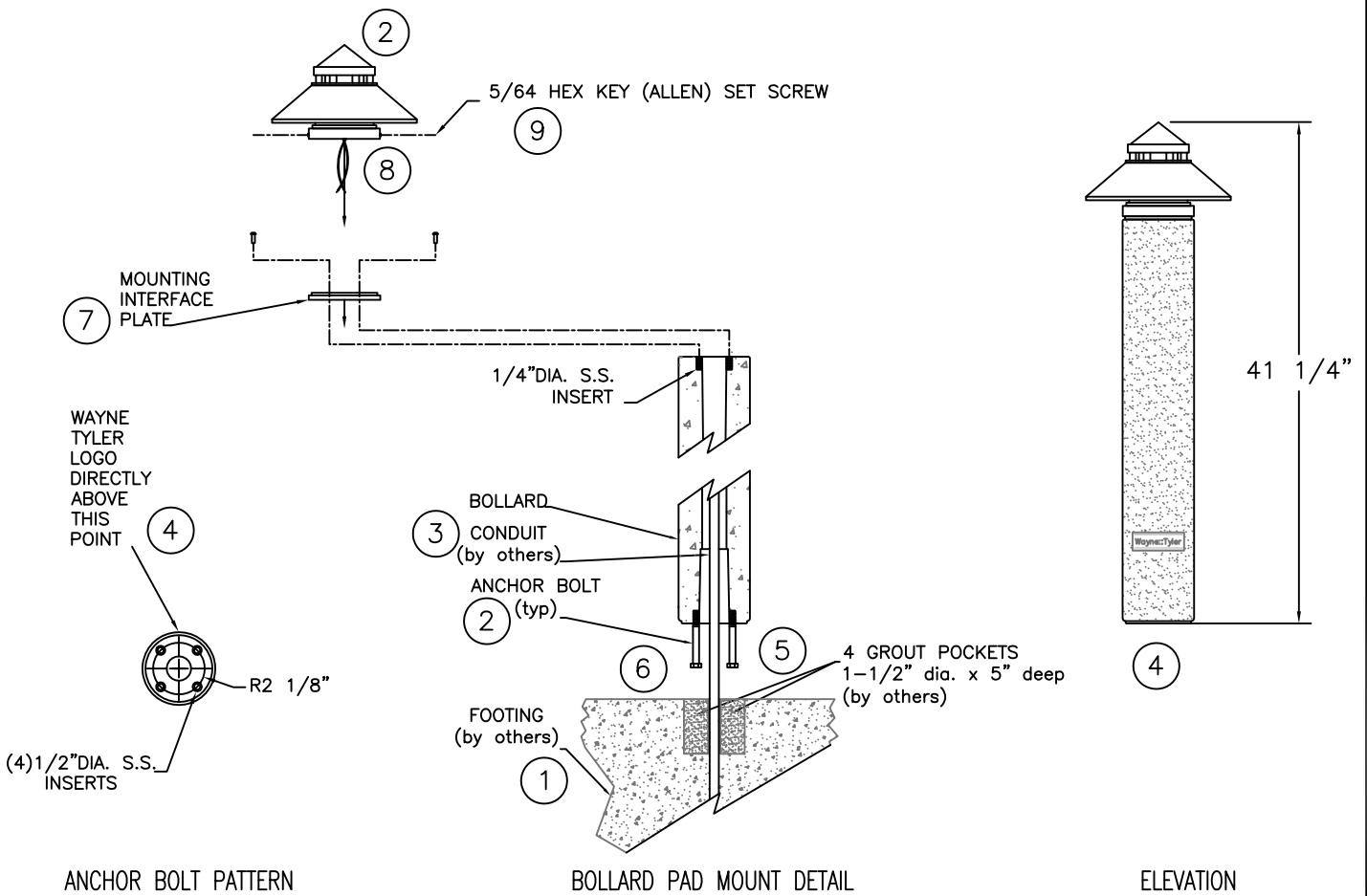

MOUNTING AND INSTALLATION INSTRUCTION SUBJECT TO CHANGE/UPDATE. SEEK THE MOST RECENT VERSION. 6/2017

	PLAN TYPE:	MOUNTING AND INSTALLATION	DATE:	06/14/17	FILE NO:	320CS	SHEET 1 OF 1
	PRODUCT:	320CS-LIGHTED CONCRETE BOLLARD	SCALE:	AS NOTED	DRAWN BY:	BGH	
	MOUNTING TYPE:	PAD MOUNT					