

INSTALLATION NOTES:

1. FOOTING MATERIALS & INSTALLATION BY OTHERS. TOOLS BY OTHERS.
2. BOLTS PROVIDED.
3. CHOOSE DIRECTION WAYNE TYLER LOGO ON BOLLARD WALL SHOULD FACE. CAST-IN OR CORE DRILL (4) 1-1/2" DIA. x 5" DEEP GROUT POCKETS INTO FOOTING PER ANCHOR BOLT PATTERN.
4. TAKE (4) 1/2" DIA. x 4-1/2" LONG ANCHOR BOLTS AND SCREW AN INCH DEEP INTO (4) 1/2" DIA. S.S. THREADED INSERTS, LEAVING 3-1/2" OF THE ANCHOR BOLT EXPOSED.
5. FILL ALL GROUT POCKETS WITH NON-SHRINK GROUT. INSERT BOLLARD WITH ANCHOR BOLTS INTO GROUT POCKETS.

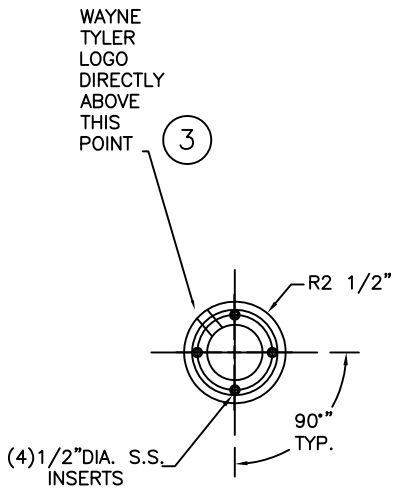

ANCHOR BOLT PATTERN

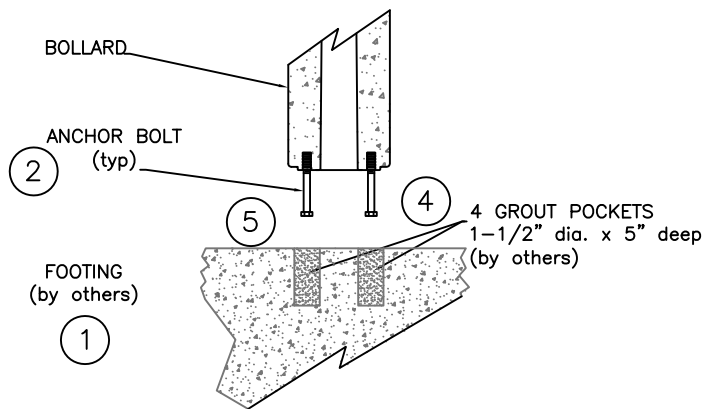

BOLLARD PAD MOUNT DETAIL

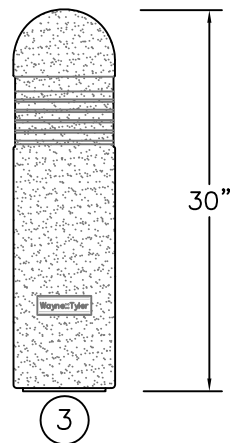

ELEVATION

MOUNTING AND INSTALLATION INSTRUCTION SUBJECT TO CHANGE/UPDATE. SEEK THE MOST RECENT VERSION. 5/2017

	PLAN TYPE:	MOUNTING AND INSTALLATION	DATE:	06/01/17	FILE NO.	284NL	SHEET 1 OF 1
	PRODUCT:	284NL NON-LIT CONCRETE BOLLARD	SCALE:	AS NOTED	DRAWN BY:	BGH	
	MOUNTING TYPE:	PAD MOUNT					